

# PCMflash module 31

Mitsubishi K-Line/Bootloader

## Contents/Оглавление

Contents/Оглавление.....	2
KIA/HYUNDAI (1999-2005) MH7203FA/MH8206F .....	3
HYUNDAI SONATA II (2000-2003) MH7202A+MH7202A .....	4
MITSUBISHI MH7201F/MH7202F/MH7203FA .....	5
MITSUBISHI CARISMA, LANCER EVO IX, PAJERO PININ MT (GDI) MH8201F.....	6
MITSUBISHI LANCER EVO V, EVO VI, EVO VII, EVO VIII, LANCER IX, PAJERO 2.5-3.2, TR4 MH8206F .....	7
MITSUBISHI CARISMA, LANCER 2.0 NA, OUTLANDER I, PAJERO 3.0-3.8L MH8302F.....	8
MITSUBISHI GRANDIS 2.4L, OUTLANDER 4G69 MIVEC 2003-2007, PAJERO V8(V9) 2007-2008 MH8304 ....	9
MITSUBISHI COLT (2003), ECLIPSE 3.8, GALANT MH8302F.....	10
MITSUBISHI COLT Z3X (2004-2011) MH8304F .....	11
MITSUBISHI ASX, LANCER X (EVO X), OUTLANDER 2.4-3.0 MH8104F/8106F/8115F.....	12
MAZDA 3/5/6/CX-7 Gen2 MH8106F/MH8110F.....	13
SUBARU LEGACY (JDM) EJ204 .....	14
SUZUKI GRAND VITARA MT 2004 MH7203F.....	15
SUZUKI MH8102F .....	16
SUZUKI MH8115F .....	17
SUZUKI GRAND VITARA MH8305F .....	18
SUZUKI BOAT MH8xxx.....	19

# PCMflash

Engine Control Unit

MH7203FA/MH8206F

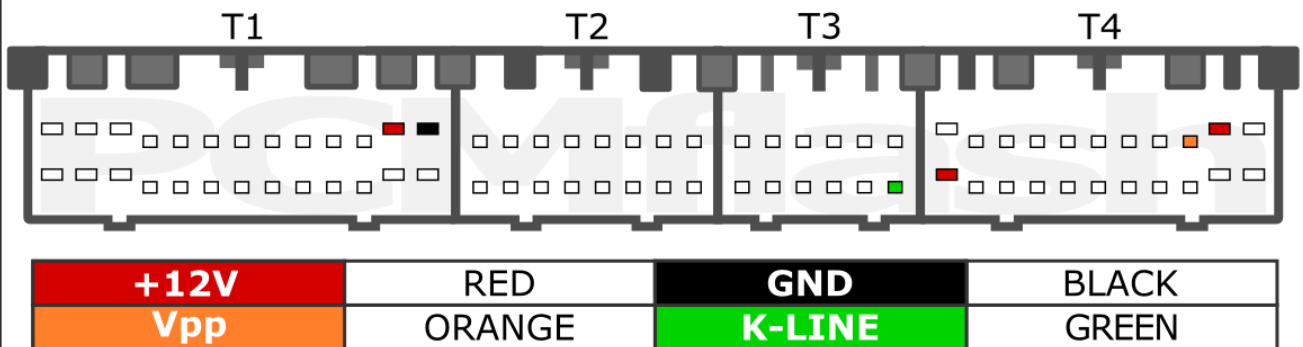

KIA/HYUNDAI (1999-2005)

pcmflash.ru

v.1

2022-01-14

# PCMflash

Engine Control Unit + Transmission Control Unit

## MH7202A + MH7202A

### HYUNDAI SONATA II

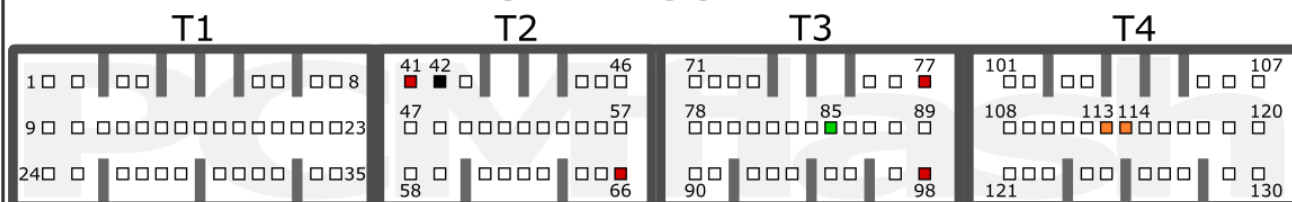

<b>+12V</b>	T2: 41, 66; T3: 77, 98	<b>GND</b>	T2: 42
<b>Vpp</b>	T4: 113, 114	<b>K-LINE</b>	T3: 85

HYUNDAI SONATA II (2000-2003)

pcmflash.ru

v.1

2022-01-14

# PCMflash

Engine Control Unit

MH7201F/MH7202F/MH7203FA

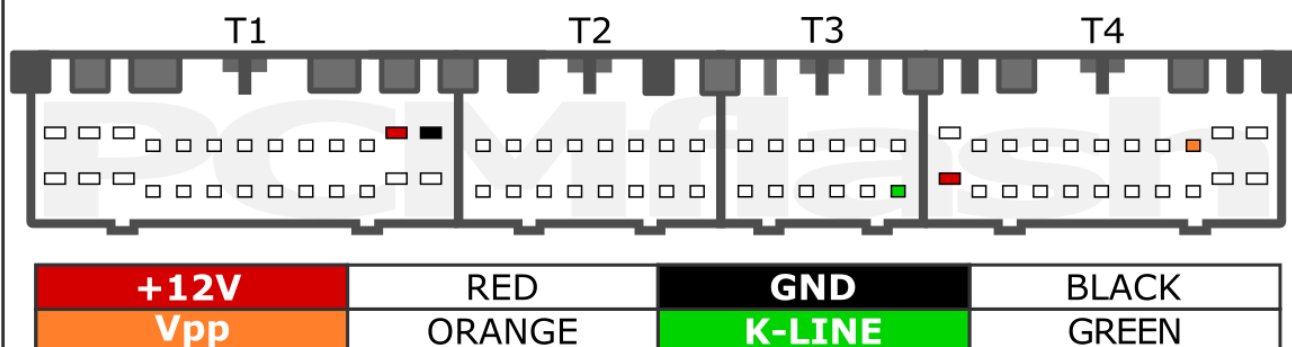

MITSUBISHI

pcmflash.ru

v.1

2023-02-18

# PCMflash

Engine Control Unit

## MH8201F

### CARISMA, PAJERO PININ MT (GDI)

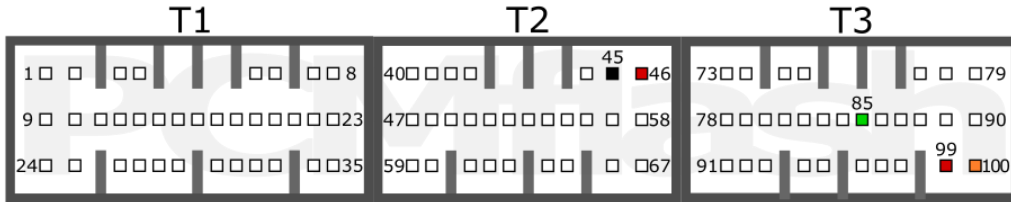

<b>+12V</b>	T2: 46; T3: 99	<b>GND</b>	T2: 45
<b>Vpp</b>	T3: 100	<b>K-LINE</b>	T3: 85

### LANCER EVO IX

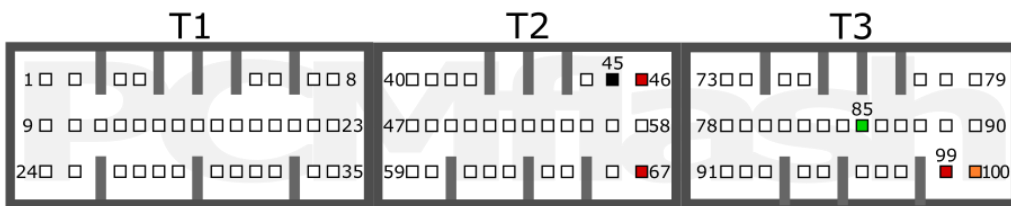

<b>+12V</b>	T2: 46, 67; T3: 99	<b>GND</b>	T2: 45
<b>Vpp</b>	T3: 100	<b>K-LINE</b>	T3: 85

CARISMA

LANCER EVO IX

PAJERO PININ MT (GDI)

pcmflash.ru

v.1

2021-12-26

# PCMflash

Engine Control Unit

## MH8206F

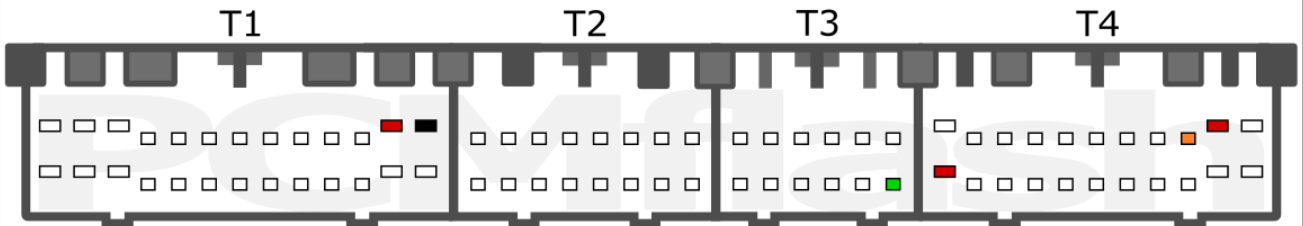

<b>+12V</b>	RED	<b>GND</b>	BLACK
<b>Vpp</b>	ORANGE	<b>K-LINE</b>	GREEN

LANCER EVO V, EVO VI, EVO VII, EVO VIII, LANCER IX | PAJERO 2.5-3.2, TR4

pcmflash.ru

v.1

2021-12-26

# PCMflash

Engine Control Unit

## MH8302F

### CARISMA, LANCER 2.0 NA, OUTLANDER I

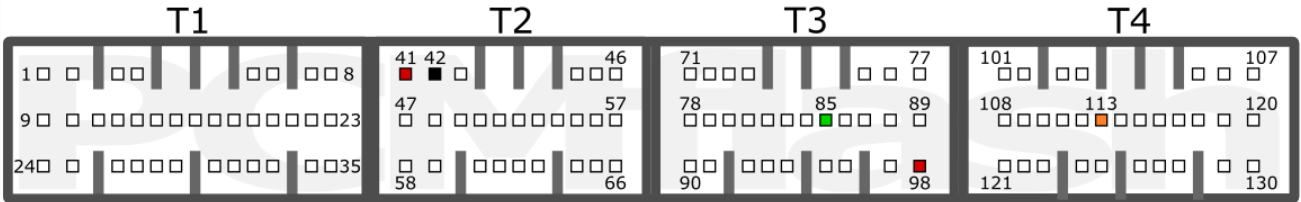

<b>+12V</b>	T2: 41; T3: 98	<b>GND</b>	T2: 42
<b>Vpp</b>	T4: 113	<b>K-LINE</b>	T3: 85

### PAJERO 3.0-3.8L

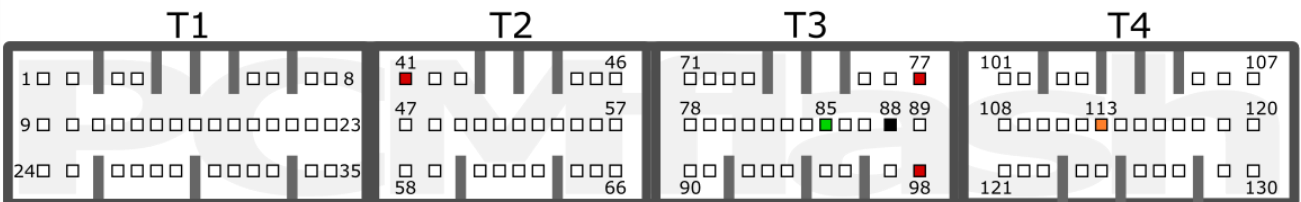

<b>+12V</b>	T2: 41; T3: 77, 98	<b>GND</b>	T3: 88
<b>Vpp</b>	T4: 113	<b>K-LINE</b>	T3: 85

CARISMA

LANCER 2.0 NA

OUTLANDER I

PAJERO 3.0-3.8L

pcmflash.ru

v.1

2022-01-18



# PCMflash

Engine Control Unit

## MH8304

OUTLANDER 4G69 MIVEC 2003-2007, PAJERO V8(V9) 2007-2008

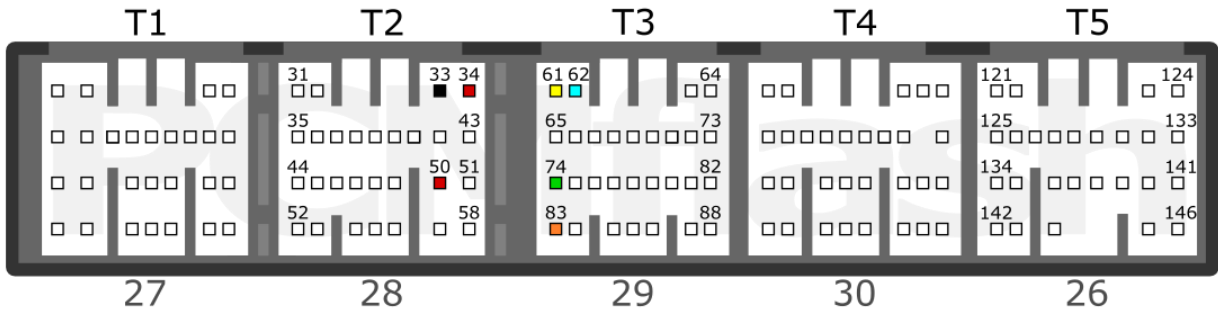

<b>+12V</b>	T2: 34, 50	<b>GND</b>	T2: 33
<b>Vpp</b>	T3: 83	<b>K-LINE</b>	T3: 74
<b>CAN-L</b>	T3: 62 (Not used)	<b>CAN-H</b>	T3: 61 (Not used)

### GRANDIS 2.4L

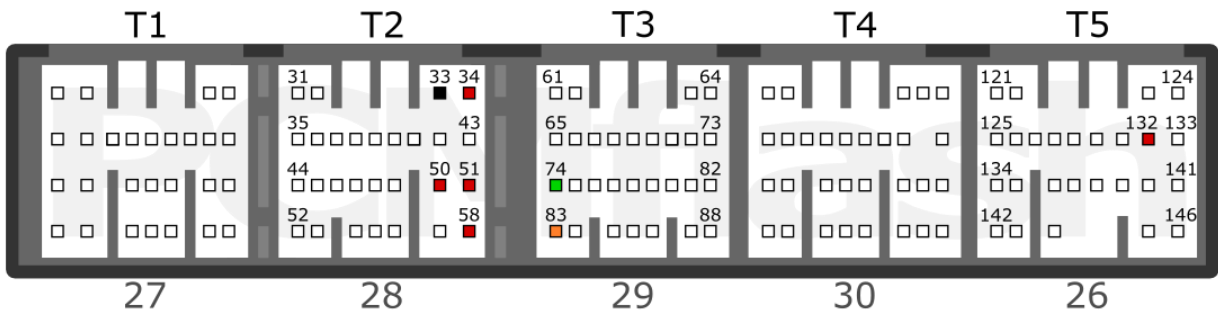

<b>+12V</b>	T2: 34, 50, 51, 58; T5: 132	<b>GND</b>	T2: 33
<b>Vpp</b>	T3: 83	<b>K-LINE</b>	T3: 74

GRANDIS 2.4L

OUTLANDER 4G69 MIVEC 2003-2007

PAJERO V8(V9) 2007-2008

pcmflash.ru

v.1

2022-01-18

# PCMflash

Engine Control Unit

## MH8302F

### COLT (2003)

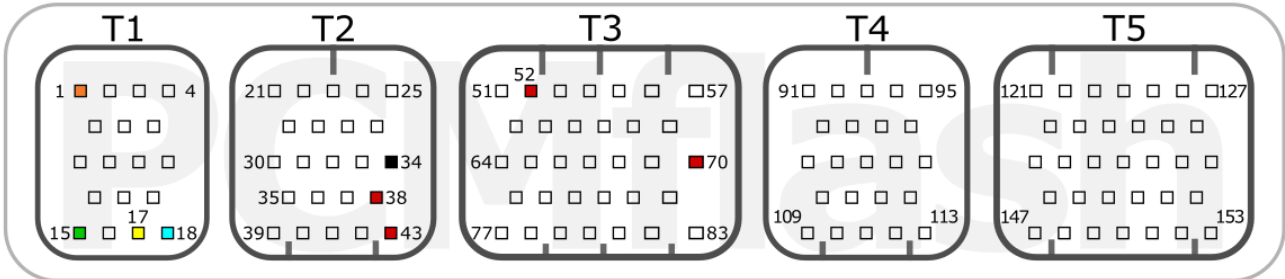

<b>+12V</b>	T2: 38, 43; T3: 52, 70	<b>GND</b>	T2: 34
<b>Vpp</b>	T1: 1	<b>K-LINE</b>	T1: 15
<b>CAN-L</b>	T1: 18 (Not used)	<b>CAN-H</b>	T1: 17 (Not used)

### ECLIPSE 3.8

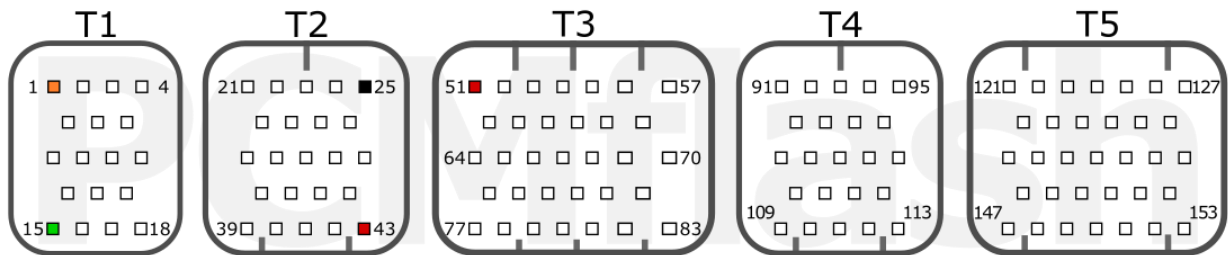

<b>+12V</b>	T2: 43; T3: 51	<b>GND</b>	T2: 25
<b>Vpp</b>	T2: 25	<b>K-LINE</b>	T1: 15

### GALANT

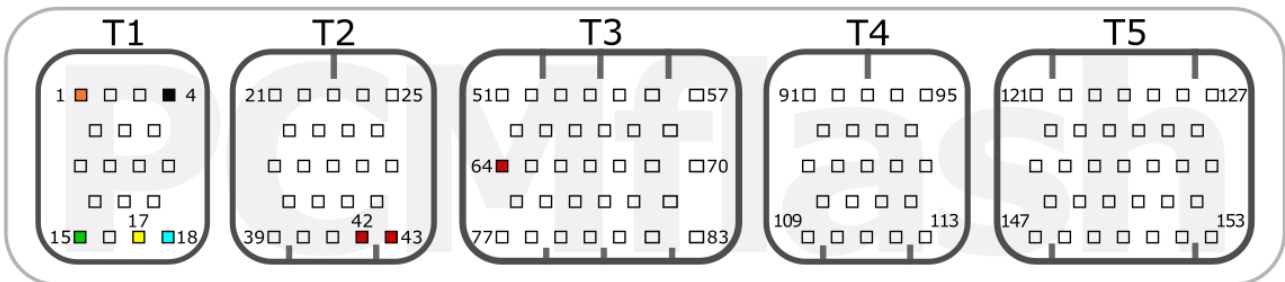

<b>+12V</b>	T2: 42, 43; T3: 64	<b>GND</b>	T1: 4
<b>Vpp</b>	T1: 1	<b>K-LINE</b>	T1: 15
<b>CAN-L</b>	T1: 18 (Not used)	<b>CAN-H</b>	T1: 17 (Not used)

COLT (2003)

ECLIPSE 3.8

GALANT

pcmflash.ru

v.1

2022-01-17

# PCMflash

Engine Control Unit

## MH8304F

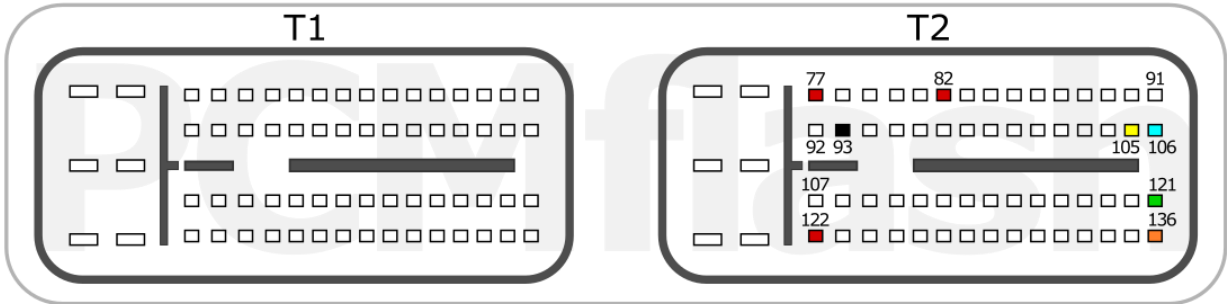

<b>+12V</b>	T2: 77, 82, 122	<b>GND</b>	T2: 93
<b>Vpp</b>	T2: 136	<b>K-LINE</b>	T2: 121
<b>CAN-L</b>	T2:106 (Not used)	<b>CAN-H</b>	T2:105 (Not used)

COLT Z3X (2004-2011)

pcmflash.ru

v.1

2021-12-26

# PCMflash

Engine Control Unit

MH8104F/8106F/8115F

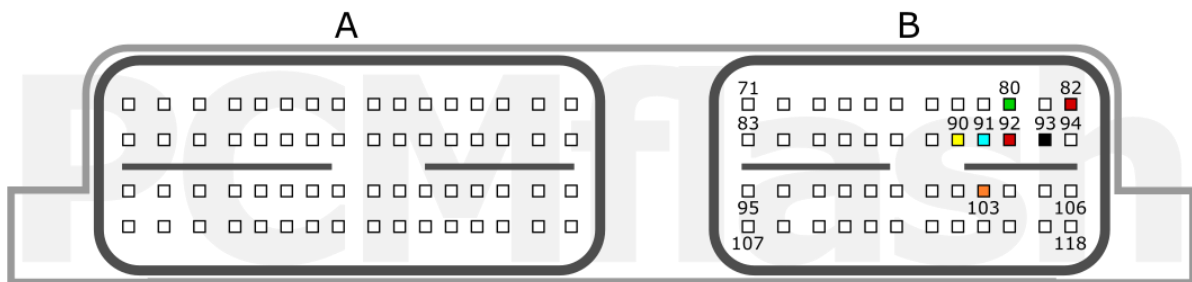

<b>+12V</b>	B: 82, 92	<b>GND</b>	B: 93
<b>Vpp</b>	B: 103	<b>K-LINE</b>	B: 80
<b>CAN-L</b>	B:91 (Not used)	<b>CAN-H</b>	B:90 (Not used)

ASX	LANCER X (EVO X)	OUTLANDER 2.4-3.0	
pcmflash.ru		v.1	2021-12-26

# PCMflash

Engine Control Unit

## MH8106F/MH8110F

### Connection version 1

A

B

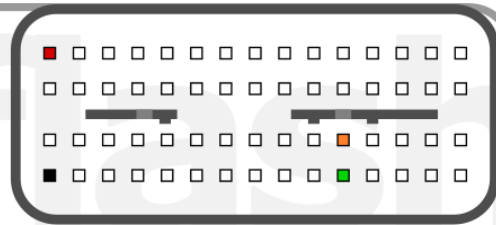
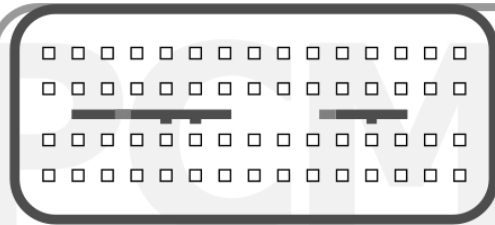

<b>+12V</b>	B: RED	<b>GND</b>	B: BLACK
<b>Vpp</b>	B: ORANGE	<b>K-LINE</b>	B: GREEN

### Connection version 2

A

B

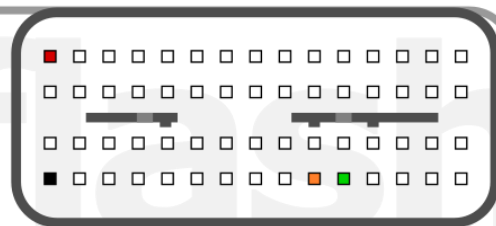
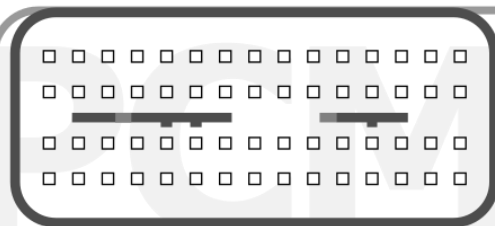

<b>+12V</b>	B: RED	<b>GND</b>	B: BLACK
<b>Vpp</b>	B: ORANGE	<b>K-LINE</b>	B: GREEN

### Connection version 3

A

B

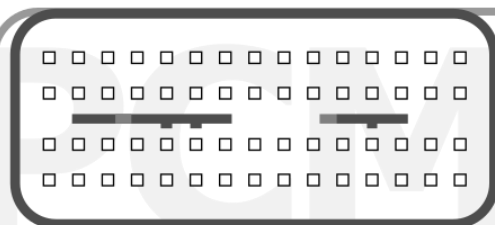

<b>+12V</b>	B: RED	<b>GND</b>	B: BLACK
<b>Vpp</b>	B: ORANGE	<b>K-LINE</b>	B: GREEN

MAZDA 3/5/6/CX-7 Gen2

pcmflash.ru

v.1

2022-04-04

# PCMflash

Engine Control Unit

## EJ204

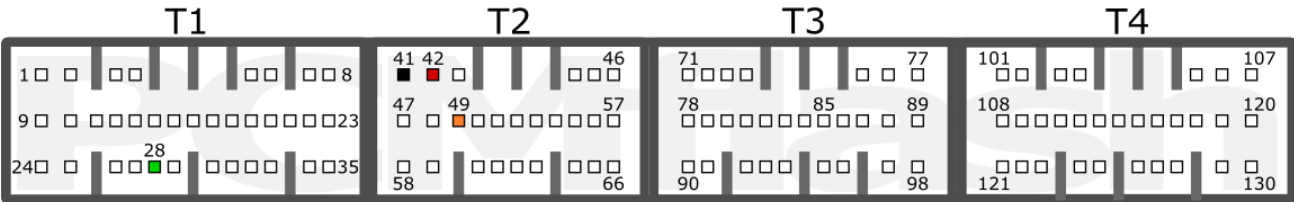

<b>+12V</b>	T2: 42	<b>GND</b>	T2: 41
<b>Vpp</b>	T2: 49	<b>K-LINE</b>	T1: 28

SUBARU LEGACY (JDM)

pcmflash.ru

v.1

2021-12-26

# PCMflash

Engine Control Unit

## MH7203F

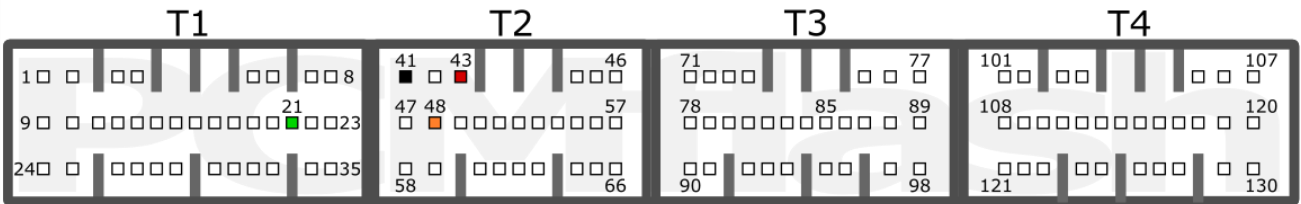

<b>+12V</b>	T2: 43	<b>GND</b>	T2: 41
<b>Vpp</b>	T2: 48	<b>K-LINE</b>	T1: 21

SUZUKI GRAND VITARA MT 2004

pcmflash.ru

v.1

2021-12-26

# PCMflash

Engine Control Unit

## MH8102F

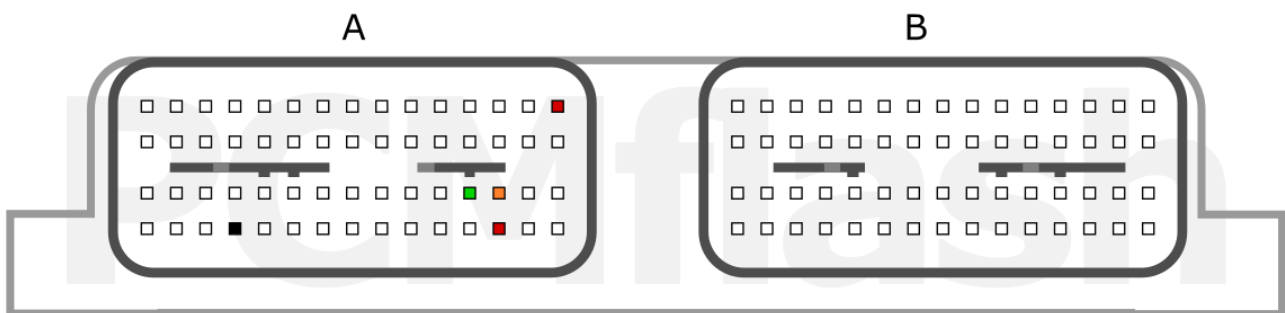

<b>+12V</b>	B: RED	<b>GND</b>	B: BLACK
<b>Vpp</b>	B: ORANGE	<b>K-LINE</b>	B: GREEN

SUZUKI

pcmflash.ru

v.1

2023-02-18



# PCMflash

Engine Control Unit

## MH8115F

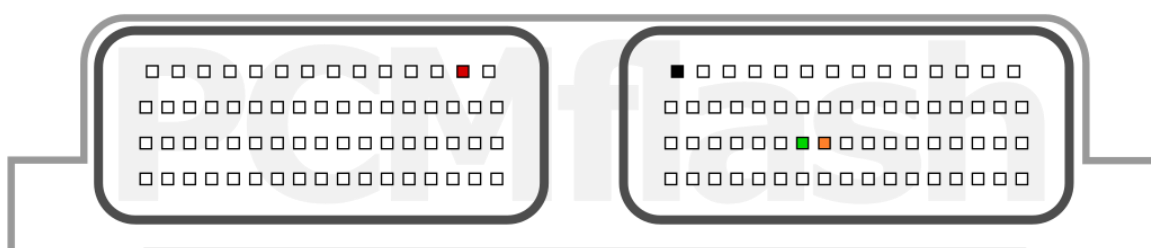

<b>+12V</b>	RED	<b>GND</b>	BLACK
<b>Vpp</b>	ORANGE	<b>K-LINE</b>	GREEN

SUZUKI

pcmflash.ru

v.1

2023-02-18

# PCMflash

Engine Control Unit

## MH8305F

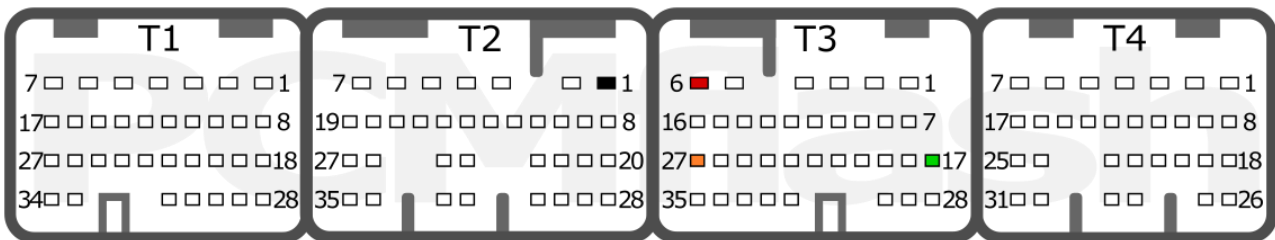

<b>+12V</b>	T3: 6	<b>GND</b>	T2: 1
<b>Vpp</b>	T3: 27	<b>K-LINE</b>	T3: 17

SUZUKI GRAND VITARA

pcmflash.ru

v.1

2021-12-26

# PCMflash

Engine Control Unit

## MH8xxx

### TYPE 1

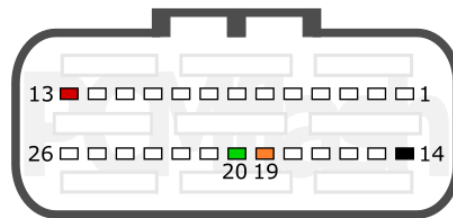

<b>+12V</b>	13	<b>GND</b>	14
<b>Vpp</b>	19	<b>K-LINE</b>	20

### TYPE 2

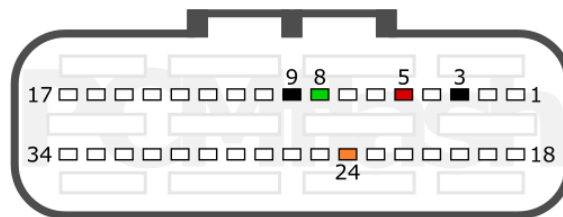

<b>+12V</b>	5	<b>GND</b>	3, 9
<b>Vpp</b>	24	<b>K-LINE</b>	8

### TYPE 3

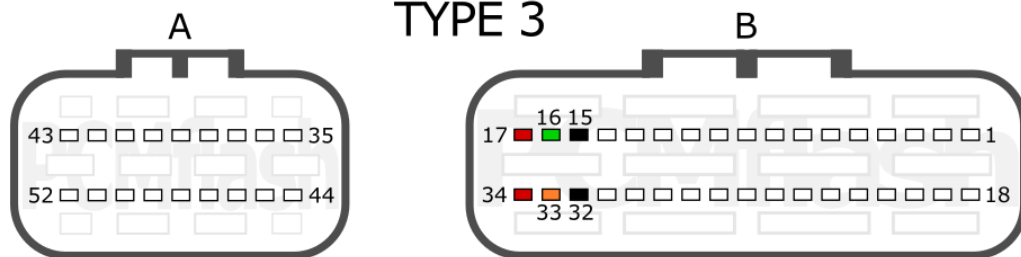

<b>+12V</b>	B: 17, 34	<b>GND</b>	B: 15, 32
<b>Vpp</b>	B: 33	<b>K-LINE</b>	B: 16

SUZUKI BOAT

pcmflash.ru

v.1

2023-02-20